

# Classic 300

## Classic 350 Fuel Filler Cap, Non- Locking Ø51.0mm Integral Neck.

Part Number: OM-ZA-003 (C350DN)

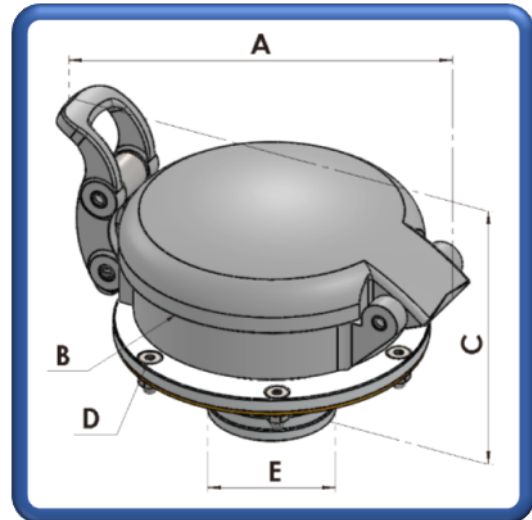

### Options:

#### Part Description

Classic 350 Fuel Filler Cap, Locking, Ø51.0mm Integral Neck

#### Part Number

OM-ZA-004 (C350DNL)

### Specifications:

#### Options:

#### Fixing Arrangement:

#### Applications:

#### Compatibilities:

#### Finish:

#### Weight:

#### Supplied With:

N/A

6 x M5 CSK Bolts

Fuel, Oil & Water Tanks

Compatible with Add Blue

Operation Temperature -40°C to +80°C

Natural Polish

430.0 grams

Cap

Flange Neck

M5 Screw Pack

### Materials:

#### Centre Cap:

#### Flange:

#### O-Ring:

#### Seal Plate:

#### Gasket:

Zinc Die-Cast Chrome plated

Aluminium Alloy 6082/T6

Viton A (FPM or FKM)

Brass

NBR Cork

### Dimensions:

#### Length A:

#### Width B:

#### Height C:

#### PCD D:

#### Height + Diameter E:

172.0mm

84.0mm

119.0mm

6 x M5 CSK Bolts on a 114.3mm PCD

Ø51.0 x 35.0mm

### Optional('s):

Lead-Free

Locking Cap

### **Fluid Containment – When It Matters**

Tell: +4420 8594 7990 / Fax: +4420 8594 7989 / [www.newton-equipment.com](http://www.newton-equipment.com) / [info@newton-equipment.com](mailto:info@newton-equipment.com)

Registered in England. 6 Orwell Close/ Fairview Ind. Park/ Rainham/ Essex/ RM13 8UB