

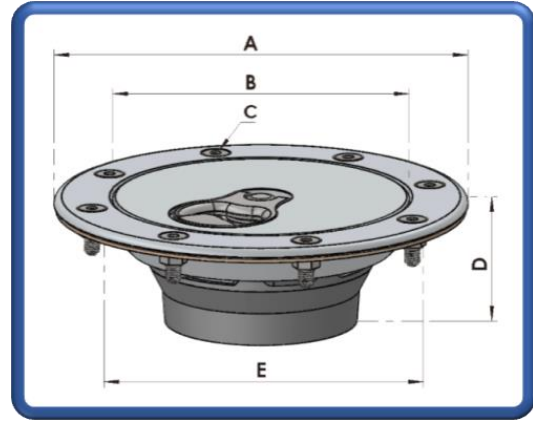

Aero 500

A500 Fuel Filler Cap, Non-Vented, Non-Locking, Silver, Flange.

Part Number: OD-ZA-001 (A58S)



Options:

Part Description

A500 Fuel Filler Cap, Non-Vented, Locking, Silver, Flange:

Part Number

OD-ZA-003 (A58L)

Specifications:

Fixing Arrangement:

Applications:

Compatibilities:

Finish:

Weight:

Supplied With:

8 x M05 CSK Bolts

Fuel, Oil & Water Tanks

Compatible with Jet Fuel 100LL

Operation Temperature -40°C to +80°C

Anodised

325.0 grams

Cap

Flange

Screw Pack (CSK Bolts, Washers & Nyloc Nuts)

Gasket

Materials:

Centre Cap:

O-Ring:

Saddle:

Lever & Centre Pin:

Washer & Nyloc Nut:

Gasket:

Aluminium Alloy 6082/T6

Viton A (FPM or FKM)

Acetal POM Kepital F20-03

Stainless Steel 303/304

Stainless Steel A2 Type

Neoprene Bonded Cork (NBR)

Dimensions:

Outside Diameter A:

Centre Diameter B:

Bolts Circle Diameter C:

Depth D:

Spigot E:

Neck Diameter:

Flange Thickness:

139.0mm

99.5mm

117.5mm

40.0mm (Adjustable)

106.0 (Ø107 Cut-Out)

N/A

3.25mm

Optional('s):

Lanyard

Hard Anodising

Viton (FPM) Gasket

Fluid Containment – When It Matters

Tell: +4420 8594 7990 / Fax: +4420 8594 7989 / www.newton-equipment.com / info@newton-equipment.com

Registered in England. 6 Orwell Close/ Fairview Ind. Park/ Rainham/ Essex/ RM13 8UB